



# melett





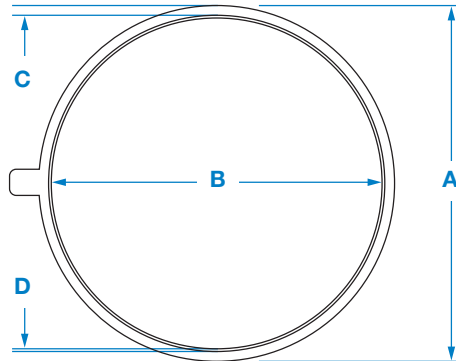

PRECISION ENGINEERED  
TURBOCHARGERS & PARTS

melett.com

### Identification

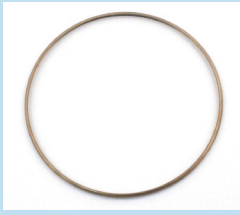

- A** Gasket outer dimension (OD)
- B** Gasket inner dimension (ID)
- C** Width of gasket
- D** Depth/thickness of gasket

Melett Part Number	Description	Melett Part Number	Description
<b>1100-030-790</b> 	<b>Turbo Model:</b> T3 <b>Location:</b> Bearing Housing - Compressor Housing <b>A - OD (mm):</b> 122 <b>B - ID (mm):</b> 112 <b>C - Width (mm):</b> 4.5 <b>D - Depth (mm):</b> 0.5 <b>Section:</b> Flat <b>Material:</b> Paper	<b>1102-015-799</b> 	<b>Turbo Model:</b> GT15-25 <b>Location:</b> Bearing Housing - Turbine Housing <b>A - OD (mm):</b> 114.5 <b>B - ID (mm):</b> 108.5 <b>C - Width (mm):</b> 3.5 <b>D - Depth (mm):</b> 0.5 <b>Section:</b> Flat <b>Material:</b> Steel
<b>1102-015-795</b> 	<b>Turbo Model:</b> GT15-25 <b>Location:</b> Bearing Housing - Turbine Housing <b>A - OD (mm):</b> 106 <b>B - ID (mm):</b> 100 <b>C - Width (mm):</b> 3.5 <b>D - Depth (mm):</b> 0.5 <b>Section:</b> Flat <b>Material:</b> Metal	<b>1102-017-795</b> 	<b>Turbo Model:</b> GTB <b>Location:</b> Bearing Housing - Turbine Housing <b>A - OD (mm):</b> 119 <b>B - ID (mm):</b> 115 <b>C - Width (mm):</b> 2.5 <b>D - Depth (mm):</b> 3.5 <b>Section:</b> C <b>Material:</b> Steel
<b>1102-015-796</b> 	<b>Turbo Model:</b> GT15-25 <b>Location:</b> Bearing Housing - Turbine Housing <b>A - OD (mm):</b> 105.5 <b>B - ID (mm):</b> 91 <b>C - Width (mm):</b> 7 <b>D - Depth (mm):</b> 1 <b>Section:</b> Flat <b>Material:</b> Steel	<b>1102-017-796</b> 	<b>Turbo Model:</b> GT15-25 <b>Location:</b> Bearing Housing - Turbine Housing <b>A - OD (mm):</b> 122.5 <b>B - ID (mm):</b> 114 <b>C - Width (mm):</b> 4.5 <b>D - Depth (mm):</b> 0.5 <b>Section:</b> Flat <b>Material:</b> Steel
<b>1102-015-798</b> 	<b>Turbo Model:</b> GT15-25 <b>Location:</b> Bearing Housing - Turbine Housing <b>A - OD (mm):</b> 115.5 <b>B - ID (mm):</b> 100 <b>C - Width (mm):</b> 7.5 <b>D - Depth (mm):</b> 0.5 <b>Section:</b> Flat <b>Material:</b> Steel	<b>1102-120-790</b> 	<b>Turbo Model:</b> GTA2056VK <b>Location:</b> Bearing Housing - Turbine Housing <b>A - OD (mm):</b> 113 <b>B - ID (mm):</b> 110 <b>C - Width (mm):</b> 2 <b>D - Depth (mm):</b> 4.5 <b>Section:</b> C <b>Material:</b> Steel

For further information please contact Melett sales: T: +44 (0)1226 320939 melett\_sales@wabtec.com



# melett





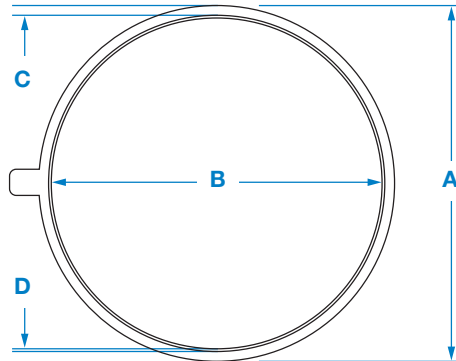

PRECISION ENGINEERED  
TURBOCHARGERS & PARTS

melett.com

### Identification

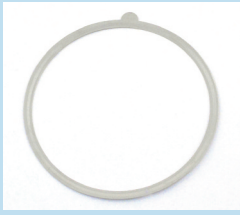

- A** Gasket outer dimension (OD)
- B** Gasket inner dimension (ID)
- C** Width of gasket
- D** Depth/thickness of gasket

Melett Part Number	Description	Melett Part Number	Description
<b>1102-220-790</b> 	<b>Turbo Model:</b> GTA2052GVK <b>Location:</b> Bearing Housing - Turbine Housing <b>A - OD (mm):</b> 114 <b>B - ID (mm):</b> 108 <b>C - Width (mm):</b> 3.5 <b>D - Depth (mm):</b> 3 <b>Section:</b> Flat <b>Material:</b> Steel	<b>1303-039-790</b> 	<b>Turbo Model:</b> BV39 <b>Location:</b> Bearing Housing - Turbine Housing <b>A - OD (mm):</b> 93.5 <b>B - ID (mm):</b> 85 <b>C - Width (mm):</b> 4.5 <b>D - Depth (mm):</b> 0.5 <b>Section:</b> Flat <b>Material:</b> Steel
<b>1102-222-790</b> 	<b>Turbo Model:</b> GTB2056VK <b>Location:</b> Bearing Housing - Turbine Housing <b>A - OD (mm):</b> 136 <b>B - ID (mm):</b> 128 <b>C - Width (mm):</b> 3.5 <b>D - Depth (mm):</b> 3.5 <b>Section:</b> C <b>Material:</b> Steel	<b>1303-039-791</b> 	<b>Turbo Model:</b> BV39 <b>Location:</b> Bearing Housing - Turbine Housing <b>A - OD (mm):</b> 100.5 <b>B - ID (mm):</b> 92 <b>C - Width (mm):</b> 4.5 <b>D - Depth (mm):</b> 0.5 <b>Section:</b> Flat <b>Material:</b> Steel
<b>1253-500-790</b> 	<b>Turbo Model:</b> S500 <b>Location:</b> Bearing Housing - Turbine Housing <b>A - OD (mm):</b> 138 <b>B - ID (mm):</b> 120 <b>C - Width (mm):</b> 9 <b>D - Depth (mm):</b> 1 <b>Section:</b> Flat <b>Material:</b> Steel	<b>1303-043-795</b> 	<b>Turbo Model:</b> BV43 <b>Location:</b> Bearing Housing - Turbine Housing <b>A - OD (mm):</b> 105 <b>B - ID (mm):</b> 92 <b>C - Width (mm):</b> 7 <b>D - Depth (mm):</b> 0.5 <b>Section:</b> Flat <b>Material:</b> Steel
<b>1303-035-790</b> 	<b>Turbo Model:</b> BV35 <b>Location:</b> Bearing Housing - Turbine Housing <b>A - OD (mm):</b> 94 <b>B - ID (mm):</b> 85.5 <b>C - Width (mm):</b> 4.5 <b>D - Depth (mm):</b> 0.5 <b>Section:</b> Flat <b>Material:</b> Steel	<b>1401-402-795</b> 	<b>Turbo Model:</b> TD02 <b>Location:</b> Bearing Housing - Compressor Housing <b>A - OD (mm):</b> 70.5 <b>B - ID (mm):</b> 65 <b>C - Width (mm):</b> 2.5 <b>D - Depth (mm):</b> 0.5 <b>Section:</b> Flat <b>Material:</b> Paper

For further information please contact Melett sales: T: +44 (0)1226 320939 melett\_sales@wabtec.com



# melett







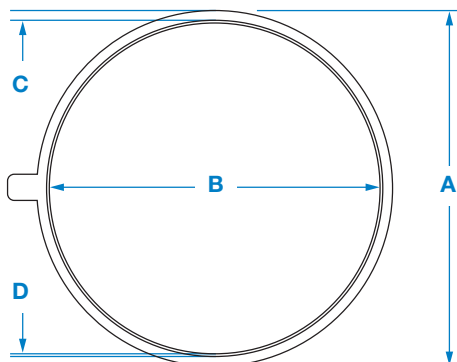

PRECISION ENGINEERED  
TURBOCHARGERS & PARTS

melett.com

### Identification



- A** Gasket outer dimension (OD)
- B** Gasket inner dimension (ID)
- C** Width of gasket
- D** Depth/thickness of gasket

Melett Part Number	Description	Melett Part Number	Description
<b>1401-402-796</b> 	<b>Turbo Model:</b> TD03 VGT <b>Location:</b> Nozzle Ring Assembly - Turbine Housing <b>A - OD (mm):</b> 55.5 <b>B - ID (mm):</b> 49.5 <b>C - Width (mm):</b> 3 <b>D - Depth (mm):</b> 3.5 <b>Section:</b> V <b>Material:</b> Steel	<b>1401-404-798</b> 	<b>Turbo Model:</b> TD04 VGT <b>Location:</b> Nozzle Ring Assembly - Turbine Housing <b>A - OD (mm):</b> 53.5 <b>B - ID (mm):</b> 47.5 <b>C - Width (mm):</b> 3 <b>D - Depth (mm):</b> 3.5 <b>Section:</b> V <b>Material:</b> Steel
<b>1401-404-790</b> 	<b>Turbo Model:</b> TD04 <b>Location:</b> Nozzle Ring Assembly - Turbine Housing <b>A - OD (mm):</b> 53.5 <b>B - ID (mm):</b> 48 <b>C - Width (mm):</b> 3 <b>D - Depth (mm):</b> 2.5 <b>Section:</b> C <b>Material:</b> Steel	<b>1401-404-799</b> 	<b>Turbo Model:</b> TD04 <b>Location:</b> Bearing Housing - Turbine Housing <b>A - OD (mm):</b> 105.5 <b>B - ID (mm):</b> 102 <b>C - Width (mm):</b> 2 <b>D - Depth (mm):</b> 3.5 <b>Section:</b> C <b>Material:</b> Steel
<b>1401-404-795</b> 	<b>Turbo Model:</b> TD04 VG <b>Location:</b> Bearing Housing - Turbine Housing <b>A - OD (mm):</b> 112 <b>B - ID (mm):</b> 101 <b>C - Width (mm):</b> 5.5 <b>D - Depth (mm):</b> 0.5 <b>Section:</b> Flat <b>Material:</b> Steel	<b>1401-635-790</b> 	<b>Turbo Model:</b> TF035 <b>Location:</b> Bearing Housing - Turbine Housing <b>A - OD (mm):</b> 114.5 <b>B - ID (mm):</b> 103.5 <b>C - Width (mm):</b> 6 <b>D - Depth (mm):</b> 0.5 <b>Section:</b> Flat <b>Material:</b> Steel
<b>1401-404-797</b> 	<b>Turbo Model:</b> TD04 VG <b>Location:</b> Bearing Housing - Turbine Housing <b>A - OD (mm):</b> 112.5 <b>B - ID (mm):</b> 101 <b>C - Width (mm):</b> 5.5 <b>D - Depth (mm):</b> 0.5 <b>Section:</b> Flat <b>Material:</b> Steel	<b>1401-635-791</b> 	<b>Turbo Model:</b> TF035 <b>Location:</b> Nozzle Ring Assembly - Turbine Housing <b>A - OD (mm):</b> 49.5 <b>B - ID (mm):</b> 43.5 <b>C - Width (mm):</b> 3 <b>D - Depth (mm):</b> 3 <b>Section:</b> V <b>Material:</b> Steel

For further information please contact Melett sales: T: +44 (0)1226 320939 melett\_sales@wabtec.com



**melett**

PRECISION ENGINEERED  
TURBOCHARGERS & PARTS

**Identification**

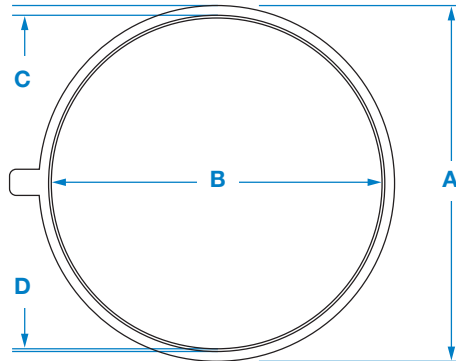

- A** Gasket outer dimension (OD)
- B** Gasket inner dimension (ID)
- C** Width of gasket
- D** Depth/thickness of gasket

Melett Part Number	Description	Melett Part Number	Description
1401-635-792	<b>Turbo Model:</b> TF035HL <b>Location:</b> Bearing Housing - Turbine Housing <b>A - OD (mm):</b> 119 <b>B - ID (mm):</b> 117.5 <b>C - Width (mm):</b> 1.5 <b>D - Depth (mm):</b> 2.5 <b>Section:</b> C <b>Material:</b> Steel	1500-326-790	<b>Turbo Model:</b> CT26 <b>Location:</b> Bearing Housing - Turbine Housing <b>A - OD (mm):</b> 56 <b>B - ID (mm):</b> 52 <b>C - Width (mm):</b> 2 <b>D - Depth (mm):</b> 2.5 <b>Section:</b> C <b>Material:</b> Steel
1401-635-793	<b>Turbo Model:</b> TF035 <b>Location:</b> Nozzle Ring Assembly - Turbine Housing <b>A - OD (mm):</b> 44 <b>B - ID (mm):</b> 47.5 <b>C - Width (mm):</b> 3.5 <b>D - Depth (mm):</b> 3.5 <b>Section:</b> V <b>Material:</b> Steel	1500-326-791	<b>Turbo Model:</b> CT26 <b>Location:</b> Bearing Housing - Turbine Housing <b>A - OD (mm):</b> 114 <b>B - ID (mm):</b> 109.5 <b>C - Width (mm):</b> 2.5 <b>D - Depth (mm):</b> 2 <b>Section:</b> C <b>Material:</b> Steel
1401-635-794	<b>Turbo Model:</b> TF035 <b>Location:</b> Bearing Housing - Turbine Housing <b>A - OD (mm):</b> 107 <b>B - ID (mm):</b> 96.5 <b>C - Width (mm):</b> 5.5 <b>D - Depth (mm):</b> 0.5 <b>Section:</b> Flat <b>Material:</b> Steel		

For further information please contact Melett sales: T: +44 (0)1226 320939 melett\_sales@wabtec.com





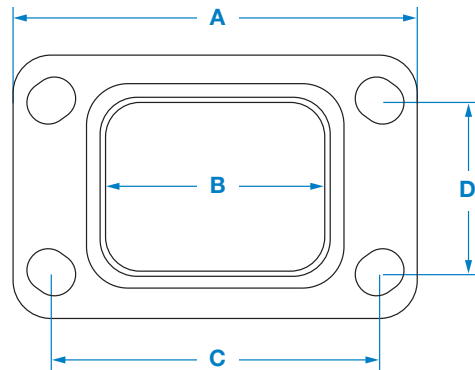

# melett

PRECISION ENGINEERED  
TURBOCHARGERS & PARTS

### Identification



- A** Gasket outer dimension
- B** Gasket inner dimension
- C** Bolt hole spacing
- D** Bolt hole spacing

Melett Part Number	Description	Melett Part Number	Description
<b>1900-000-001</b> 	<b>Turbo Model:</b> ST/VT50 <b>Location:</b> Turbine Housing Inlet <b>A - OD (mm):</b> 132.5 <b>B - ID (mm):</b> 98 <b>C - Bolt hole spacing (mm):</b> 110 <b>D - Bolt hole spacing (mm):</b> 75 <b>Section:</b> Flat <b>Material:</b> Steel	<b>1900-000-006</b> 	<b>Turbo Model:</b> 3LD T04B K27 <b>Location:</b> Turbine Housing Inlet <b>A - OD (mm):</b> 107.5 <b>B - ID (mm):</b> 66.5 <b>C - Bolt hole spacing (mm):</b> 86 <b>D - Bolt hole spacing (mm):</b> 45 <b>Section:</b> Flat <b>Material:</b> Steel
<b>1900-000-004</b> 	<b>Turbo Model:</b> S400/K36 <b>Location:</b> Turbine Housing Inlet <b>A - OD (mm):</b> 134.5 <b>B - ID (mm):</b> 92 <b>C - Bolt hole spacing (mm):</b> 112 <b>D - Bolt hole spacing (mm):</b> 70 <b>Section:</b> Flat <b>Material:</b> Steel	<b>1900-000-041</b> 	<b>Turbo Model:</b> T25 <b>Location:</b> Turbine Housing Inlet <b>A - OD (mm):</b> 92 <b>B - ID (mm):</b> 60 <b>C - Bolt hole spacing (mm):</b> 75 <b>D - Bolt hole spacing (mm):</b> 40 <b>Section:</b> Flat <b>Material:</b> Steel

For further information please contact Melett sales: T: +44 (0)1226 320939 melett\_sales@wabtec.com





**melett**

PRECISION ENGINEERED  
TURBOCHARGERS & PARTS

**Identification**

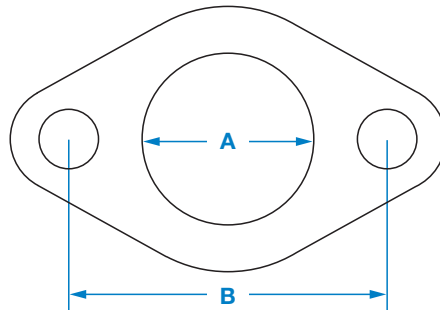

**A** Oil feed / drain diameter

**B** Bolt hole spacing

Melett Part Number	Description	Melett Part Number	Description
1500-320-790	<b>Turbo Model:</b> CT20 (Dual feed) <b>Location:</b> Bearing Housing <b>A - Oil feed / drain diameter (mm):</b> 22 <b>B - Bolt hole spacing (mm):</b> 58 <b>Section:</b> Flat <b>Material:</b> Paper	1900-000-027	<b>Turbo Model:</b> T3/T04B <b>Location:</b> Bearing Housing <b>A - Oil feed / drain diameter (mm):</b> 20x17.5 <b>B - Bolt hole spacing (mm):</b> 51 <b>Section:</b> Flat <b>Material:</b> Paper
1500-320-791	<b>Turbo Model:</b> CT20 <b>Location:</b> Bearing Housing <b>A - Water feed / drain diameter (mm):</b> 22.5 <b>B - Bolt hole spacing (mm):</b> 30 <b>Section:</b> Flat <b>Material:</b> Paper	1900-000-036	<b>Turbo Model:</b> T12/T3/T04B/3LD/4LE <b>Location:</b> Bearing Housing <b>A - Oil feed / drain diameter (mm):</b> 17 <b>B - Bolt hole spacing (mm):</b> 40 <b>Section:</b> Flat <b>Material:</b> Paper
1900-000-025	<b>Turbo Model:</b> T12 <b>Location:</b> Bearing Housing <b>A - Oil feed / drain diameter (mm):</b> 28 <b>B - Bolt hole spacing (mm):</b> 53 <b>Section:</b> Flat <b>Material:</b> Paper	1900-000-042	<b>Turbo Model:</b> TD04/05/06, K03/4 & GT15 <b>Location:</b> Bearing Housing <b>A - Oil feed / drain diameter (mm):</b> 16 <b>B - Bolt hole spacing (mm):</b> 38 <b>Section:</b> Flat <b>Material:</b> Paper
1900-000-026	<b>Turbo Model:</b> 3LD <b>Location:</b> Bearing Housing <b>A - Oil feed / drain diameter (mm):</b> 24.5 <b>B - Bolt hole spacing (mm):</b> 53 <b>Section:</b> Flat <b>Material:</b> Paper	1900-000-043	<b>Turbo Model:</b> TD04/05/06, K03/4 & GT15 <b>Location:</b> Bearing Housing <b>A - Oil feed / drain diameter (mm):</b> 14 <b>B - Bolt hole spacing (mm):</b> 45 <b>Section:</b> Flat <b>Material:</b> Paper

For further information please contact Melett sales: T: +44 (0)1226 320939 melett\_sales@wabtec.com



**melett**

PRECISION ENGINEERED  
TURBOCHARGERS & PARTS

**Identification**

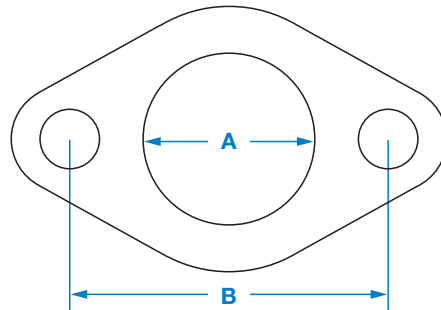

**A** Oil inlet diameter

**B** Bolt hole spacing

Melett Part Number	Description	Melett Part Number	Description
<b>1900-000-044</b>	<p><b>Turbo Model:</b> Various</p> <p><b>Location:</b> Electronic Actuator</p> <p><b>Section:</b> Flat</p> <p><b>Material:</b> Paper</p>	<b>1900-000-045</b>	<p><b>Turbo Model:</b> GTA17/18 (Dual Feed)</p> <p><b>Location:</b> Bearing Housing</p> <p><b>A - Oil feed / drain diameter (mm):</b> 18</p> <p><b>B - Bolt hole spacing (mm):</b> 52</p> <p><b>Section:</b> Flat</p> <p><b>Material:</b> Paper</p>

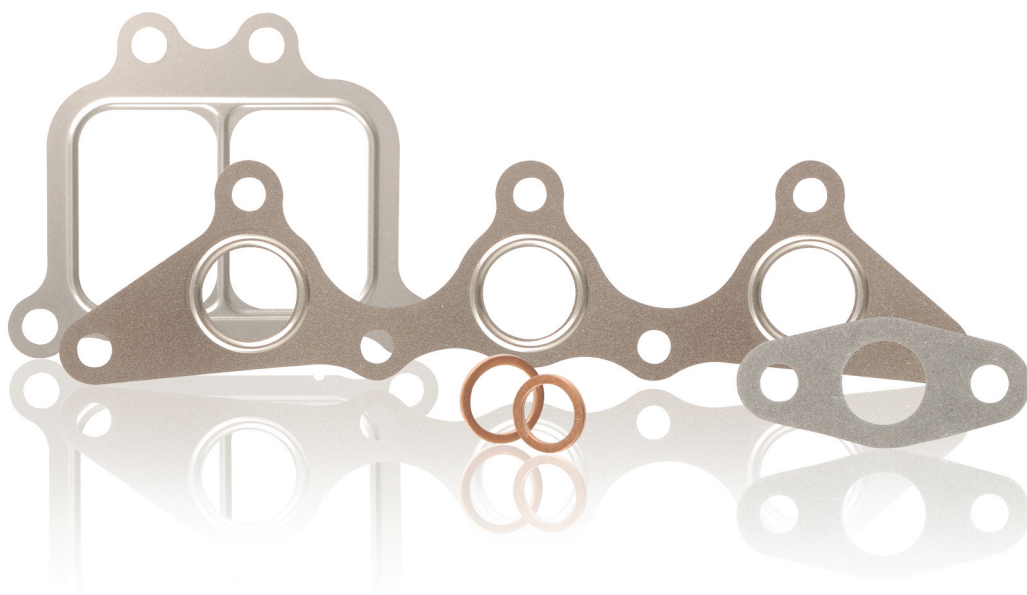

For further information please contact Melett sales: T: +44 (0)1226 320939 melett\_sales@wabtec.com